



Double Sided Wall Mount IP Display for InformaCast®

Model No: WL-IPD-SPKR-510D-INF

Description

The Wahsega Double Sided Wall Mount IP Display supports dual registration with InformaCast® and SIP. With network connectivity, scrolling LED display and built-in speaker, the Wahsega IP Display broadcasts both audible and visible messages to classroom occupants. Two integrated relays let building managers remotely lock classroom doors in the case of an emergency. A built-in microphone allows for two-way SIP communication, and time synchronization is handled by a network SNTP Server. The Wahsega IP Display can even power a second, analog Wahsega speaker up to 20 meters away via PoE cable, increasing the audio coverage in the space without requiring an additional cable home run.

Key Features

- Dual registration: SIP and InformaCast
- Automatic InformaCast server registration
- PoE 802.3af enabled (Power-over-Ethernet)
- Able to drive second Wahsega analog speaker up to 20m away via Cat5e or Cat6
- Industry-leading low standby power
- Fully configurable via simple webpages
- Integrated microphone
- Two onboard relays for door control
- RJ45 connections for simplified installation
- One to three lines of text display
- Time set by network SNTP Server with no manual adjustments necessary
- Built-in light sensor for energy-reducing auto-dim setting
- Text display is configurable
- 32,768 LED colors
- 32 x 64 resolution
- Text display up to 5" high

Job Name:	Date:	Location:
Notes:		

Double Sided Wall Mount IP Display for InformaCast

Model No: WL-IPD-SPKR-510D-INF

Specification Submittal

Specifications

- Ethernet: 10/100 Mbps
- Power Input: PoE 802.3af
- Standby power: <2 Watts
- Protocol: SIP RFC 3261 compatible
- Audio Codecs: 16-bit PCM (uncompressed), u-law (G.711u), a-law (G.711a), G.722, G.729
- Audio Sampling: 8 kHz, 16 kHz, or 32 kHz
- Speaker Drive Capabilities: 5W
- Speaker Impedance: 8Ω
- Speaker Sensitivity: 96dB 1W/0.5M SPL
- Coverage Angle: 120° / 4 kHz
- Dry Contact Relay Rating: 2A min, 250V AC, 24V DC
- Max PoE Cable Length: 100m (per standard) PoE 10/100 cable length
- Max Auxiliary Speaker Cable Length (Cat5e or Cat6): 20m
- Temperature Range: -40°C to +60°C
- Weight: 13.25 lbs
- Overall Dimensions: 20.39" W x 7.74" H x 8.25" D (bracket adds 4.95" W)
- LED Panel Dimensions: 5" tall x 10" wide
- Construction: Metal housing with polyester powdercoat paint
- Warranty: 3 years limited

Installation

The Wahsega Double Sided Wall Mount IP Display mounts to the surface of a wall, using its included mounting bracket and ½" bolts with the appropriate anchors for your surface material. An earthquake cable is connected to the included eye bolt for further stability. Power supplied via Power over Ethernet (PoE) 802.3af.

Compatibility

Extension Speakers

- 2x2 Extension Ceiling Speaker - WL-SPKR-22-A
- Wall Mount Extension Speaker - WL-SPKR-SMT-A

Accessories

- Teacher Mic Kit - WL-MIC-WIR-KIT-1-CAR
- Sound Reinforcement Panel - WL-SPKR-RSR-W
- Call / Panic Button - WL-SPKR-RB-W

Job Name:	Date:	Location:
Notes:		

Double Sided Wall Mount IP Display for InformaCast

Model No: WL-IPD-SPKR-510D-INF

Specification Submittal

Dimensions

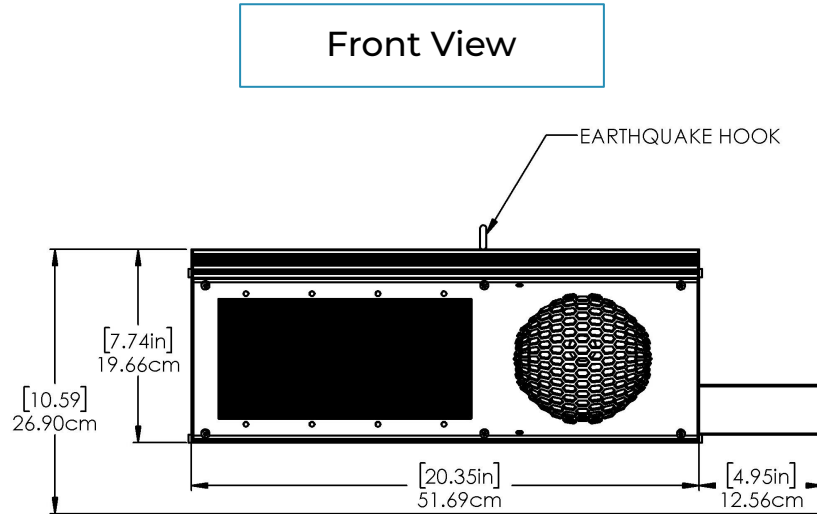

Job Name:	Date:	Location:
Notes:		

Double Sided Wall Mount IP Display for InformaCast

Model No: WL-IPD-SPKR-510D-INF

Specification Submittal

Wiring Diagram

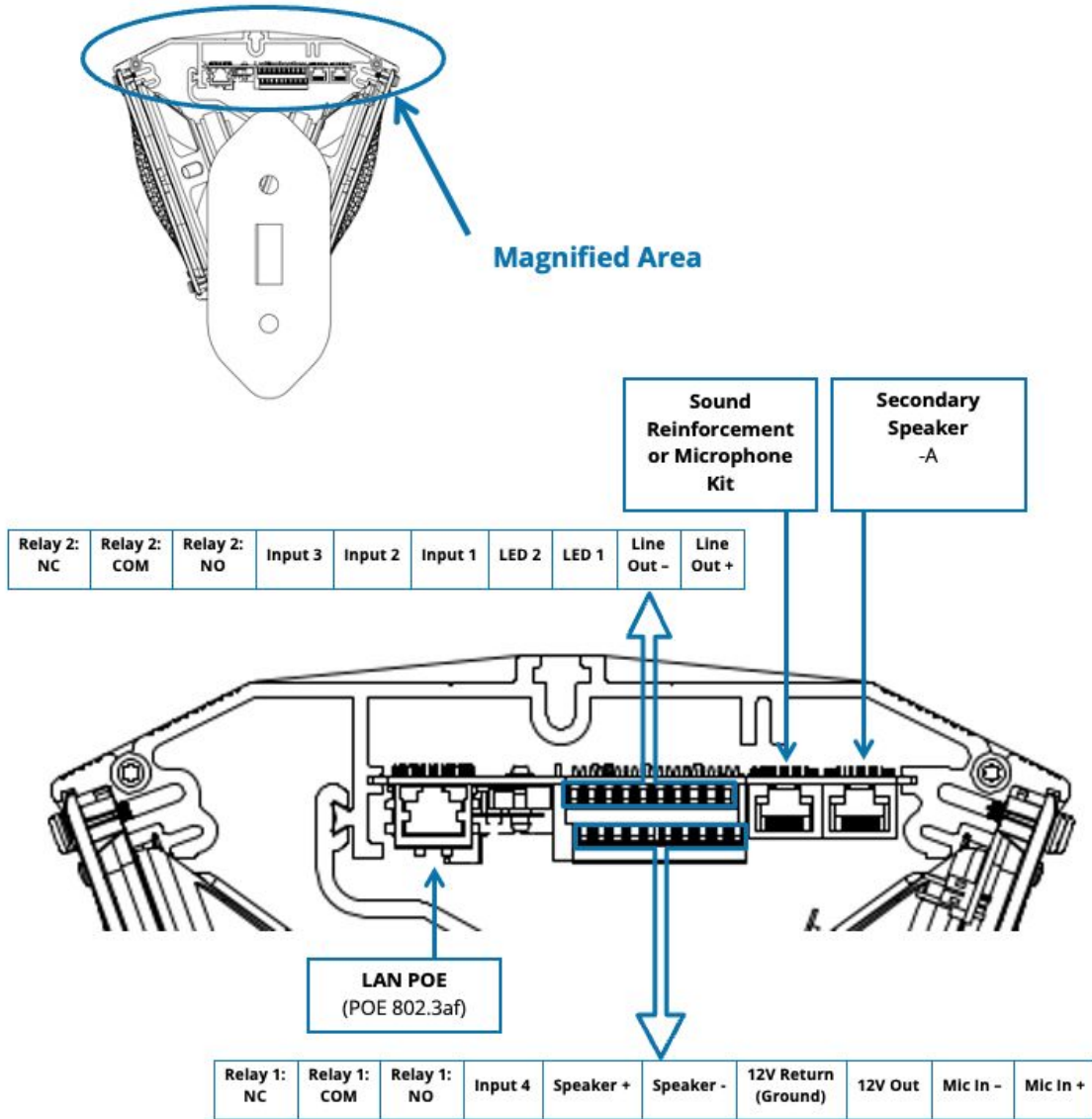

Job Name:	Date:	Location:
Notes:		

Double Sided Wall Mount IP Display for InformaCast

Model No: WL-IPD-SPKR-510D-INF

Specification Submittal

Terminal Blocks

MIC IN +	Unused
MIC IN -	Unused
12 V OUT	Fused, nominal 12V output, max 0.5A. Subject to power capabilities of PoE.
12 V RTN (GND)	Ground
SPKR -	Unused
SPKR +	Unused
INPUT 4	Contact closure to ground (<i>12 V RTN</i>). Connect a Volume Button or SNMP Variable/Trap contact using <i>Input 4</i> and <i>12 V RTN (GND)</i> .
RELAY 1: NO	Isolated dry contact closure. Normally Open.
RELAY 1: COM	Isolated dry contact closure. Common.
RELAY 1: NC	Isolated dry contact closure. Normally Closed.
LINE OUT +	Consumer line input level (-10dBV)
LINE OUT -	Consumer line input level (-10dBV)
LED 1	Unused
LED 2	Unused
INPUT 1	Contact closure to ground (<i>12 V RTN</i>). Connect a Panic/Call Button using <i>Input 1</i> and <i>12 V RTN (GND)</i> .
INPUT 2	Contact closure to ground (<i>12 V RTN</i>). Connect a Volume Button or SNMP Variable/Trap contact using <i>Input 2</i> and <i>12 V RTN (GND)</i> .
INPUT 3	Contact closure to ground (<i>12 V RTN</i>). Connect a Volume Button or SNMP Variable/Trap contact using <i>Input 3</i> and <i>12 V RTN (GND)</i> .
RELAY 2: NO	Isolated dry contact closure. Normally Open.
RELAY 2: COM	Isolated dry contact closure. Common.
RELAY 2: NC	Isolated dry contact closure. Normally Closed.

Double Sided Wall Mount IP Display for InformaCast

Model No: WL-IPD-SPKR-510D-INF

Specification Submittal

Mounting and Installation

To use Power-over-Ethernet (PoE 802.3af), route a Cat 5e or Cat 6 Ethernet cable from a PoE switch to the LAN/POE port. Once the unit is successfully powered, the LINK/ACTV indicator LED will begin to blink.

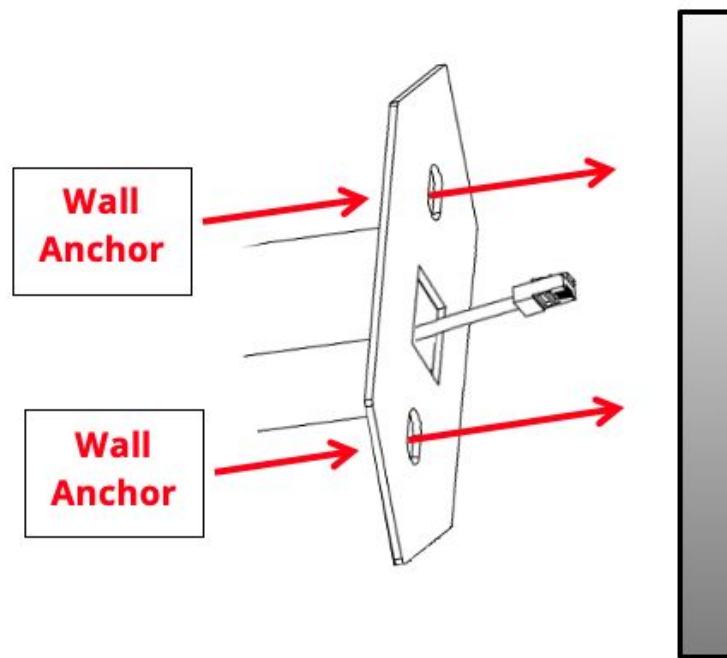

Affix mounting bracket to a solid, vertical wall surface using two bolts and anchors appropriate for the wall surface.

Route cabling through center, rectangular opening.

Job Name:	Date:	Location:
Notes:		

Double Sided Wall Mount IP Display for InformaCast

Model No: WL-IPD-SPKR-510D-INF

Specification Submittal

Mounting and Installation

For earthquake cable, affix included eye bolt and flat washer to tee-nut at the far end of the IP Display. Attach cable to eye bolt and secure to structure per local building and electrical codes.



Job Name:	Date:	Location:
Notes:		