



Extra Large IP Display for InformaCast[®]

Model No: WL-IPD-SPKR-540-INF

Description

The Wahsega Extra Large IP Display supports dual registration with InformaCast[®] and SIP. With network connectivity, scrolling LED display and built-in speaker, the Wahsega IP Display broadcasts both audible and visible messages to classroom occupants. Two integrated relays let building managers remotely lock classroom doors in the case of an emergency. A built-in microphone allows for two-way SIP communication, and time synchronization is handled by a network SNTP Server. The Wahsega IP Display can even power a second, analog Wahsega speaker up to 20 meters away via PoE cable, increasing the audio coverage in the space without requiring an additional cable home run.

Key Features

- Dual registration: SIP and InformaCast
- Automatic InformaCast server registration
- PoE 802.3af enabled (Power-over-Ethernet)
- Able to drive second Wahsega analog speaker up to 20m away via Cat5e or Cat6
- Industry-leading low standby power
- Fully configurable via simple webpages
- Integrated microphone
- Two onboard relays for door control
- RJ45 connections for simplified installation
- One to three lines of text display
- Time set by network SNTP Server with no manual adjustments necessary
- Built-in light sensor for energy-reducing auto-dim setting
- Text display is configurable
- 32,768 LED colors
- 32 x 256 resolution
- Text display up to 5" high

Job Name:	Date:	Location:
Notes:		

Extra Large IP Display for InformaCast

Model No: WL-IPD-SPKR-540-INF

Specification Submittal

Specifications

- Ethernet: 10/100 Mbps
- Power Input: PoE 802.3af
- Standby power: <2 Watts
- Protocol: SIP RFC 3261 compatible
- Audio Codecs: 16-bit PCM (uncompressed), u-law (G.711u), a-law (G.711a), G.722, G.729
- Audio Sampling: 8 kHz, 16 kHz, or 32 kHz
- Speaker Drive Capabilities: 5W
- Speaker Impedance: 8Ω
- Speaker Sensitivity: 96dB 1W/0.5M SPL
- Coverage Angle: 120° / 4 kHz
- Dry Contact Relay Rating: 2A min, 250V AC, 24V DC
- Max PoE Cable Length: 100m (per standard) PoE 10/100 cable length
- Max Auxiliary Speaker Cable Length (Cat5e or Cat6): 20m
- Temperature Range: -40°C to +60°C
- Weight: 24.5lbs
- Overall Dimensions: 58.64" W x 7" H x 4.54" D
- LED Panel Dimensions: 5" tall x 40" wide
- Construction: Metal housing with polyester powdercoat paint
- Warranty: 3 years limited

Installation

Simple, surface mount wall installation with rear conduit access and side raceway access for wiring. Power supplied via Power over Ethernet (PoE) 802.3af.

Compatibility

Extension Speakers

- 2x2 Extension Ceiling Speaker - WL-SPKR-22-A
- Wall Mount Extension Speaker - WL-SPKR-SMT-A

Accessories

- Teacher Mic Kit - WL-MIC-WIR-KIT-1-CAR
- Sound Reinforcement Panel - WL-SPKR-RSR-W
- Call / Panic Button - WL-SPKR-RB-W
- Extra Large Protection Cage - WL-IPD-SPKR-540-CG

Job Name:	Date:	Location:
Notes:		

Extra Large IP Display for InformaCast

Model No: WL-IPD-SPKR-540-INF

Specification Submittal

Dimensions

Front View

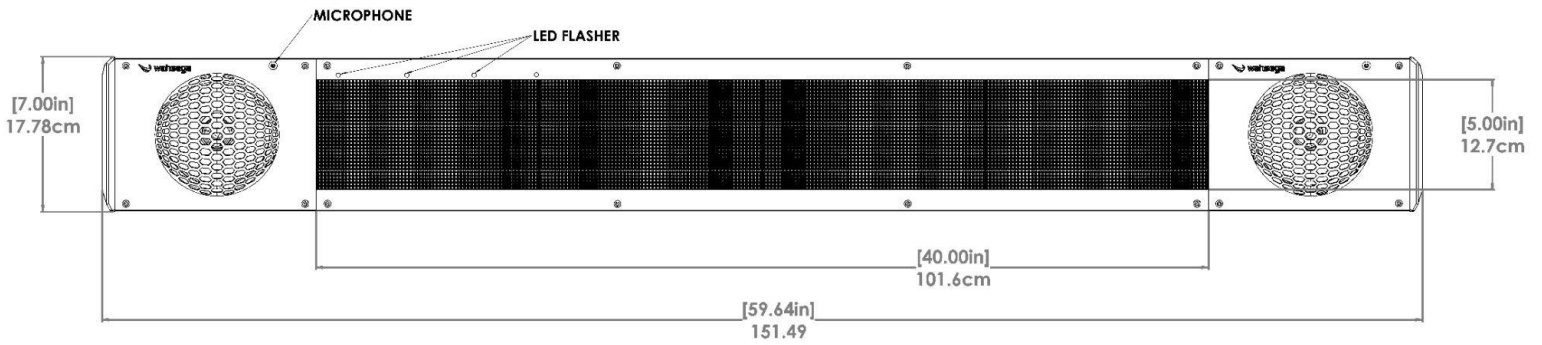

Back View

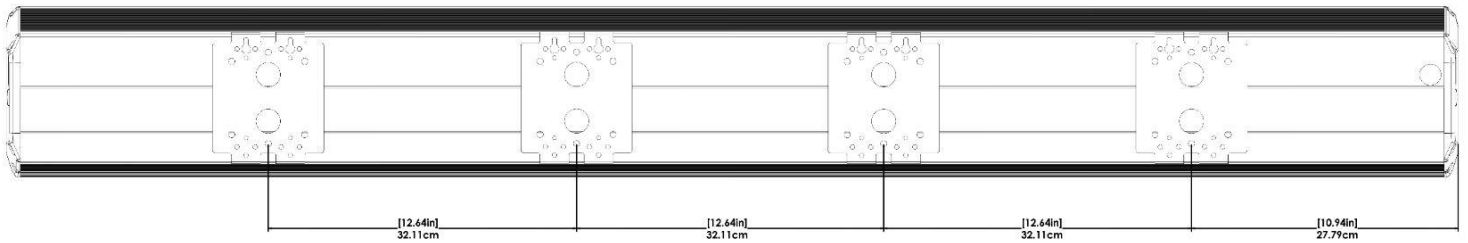

Job Name:

Date:

Location:

Notes:





Extra Large IP Display for InformaCast

Model No: WL-IPD-SPKR-540-INF

Specification Submittal

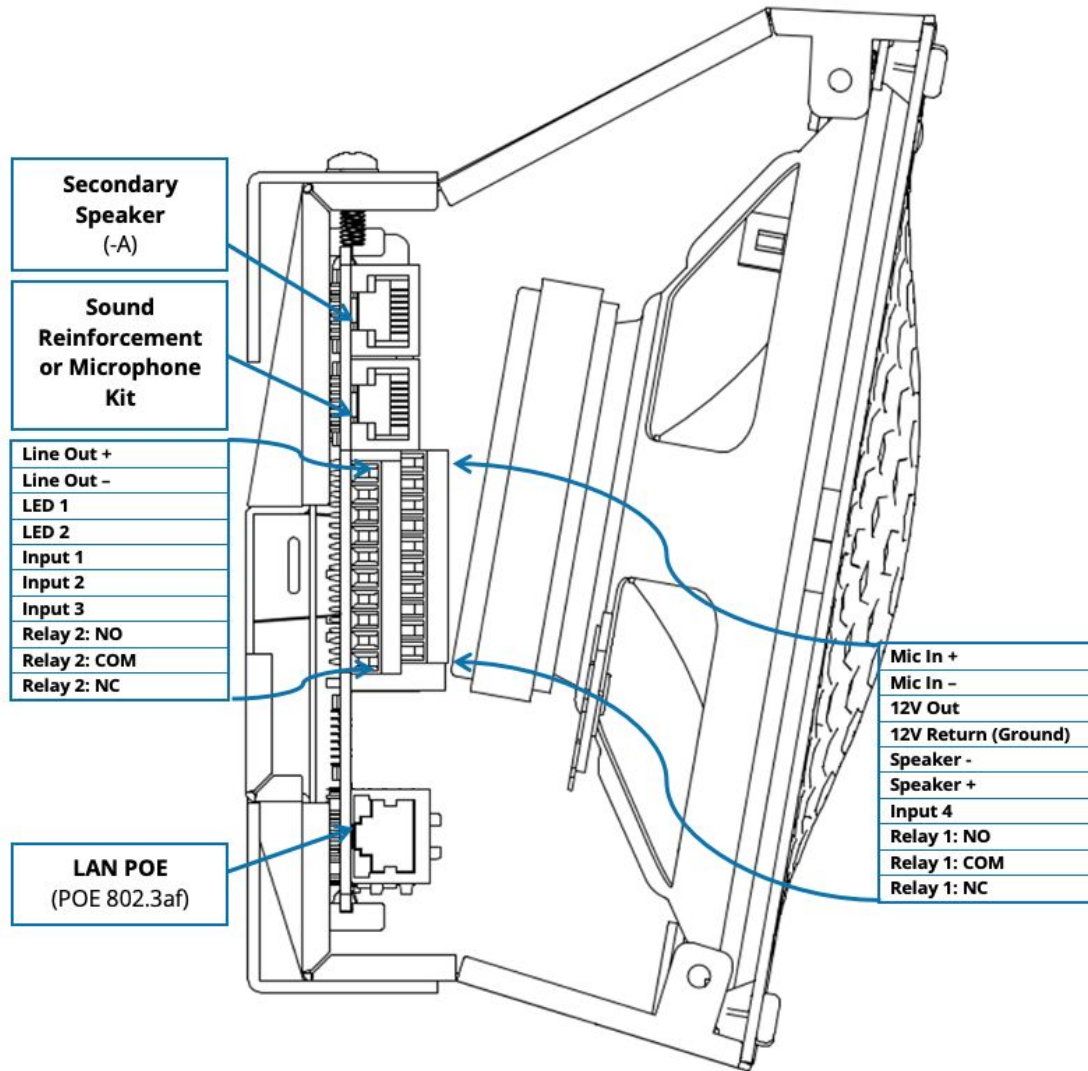
Wiring Diagram



Job Name:	Date:	Location:
Notes:		

Extra Large IP Display for InformaCast

Model No: WL-IPD-SPKR-540-INF

Specification Submittal

Terminal Blocks

MIC IN +	Unused
MIC IN -	Unused
12 V OUT	Fused, nominal 12V output, max 0.5A. Subject to power capabilities of PoE.
12 V RTN (GND)	Ground
SPKR -	Unused
SPKR +	Unused
INPUT 4	Contact closure to ground (<i>12 V RTN</i>). Connect a Volume Button or SNMP Variable/Trap contact using <i>Input 4</i> and <i>12 V RTN (GND)</i> .
RELAY 1: NO	Isolated dry contact closure. Normally Open.
RELAY 1: COM	Isolated dry contact closure. Common.
RELAY 1: NC	Isolated dry contact closure. Normally Closed.
LINE OUT +	Consumer line input level (-10dBV)
LINE OUT -	Consumer line input level (-10dBV)
LED 1	Unused
LED 2	Unused
INPUT 1	Contact closure to ground (<i>12 V RTN</i>). Connect a Panic/Call Button using <i>Input 1</i> and <i>12 V RTN (GND)</i> .
INPUT 2	Contact closure to ground (<i>12 V RTN</i>). Connect a Volume Button or SNMP Variable/Trap contact using <i>Input 2</i> and <i>12 V RTN (GND)</i> .
INPUT 3	Contact closure to ground (<i>12 V RTN</i>). Connect a Volume Button or SNMP Variable/Trap contact using <i>Input 3</i> and <i>12 V RTN (GND)</i> .
RELAY 2: NO	Isolated dry contact closure. Normally Open.
RELAY 2: COM	Isolated dry contact closure. Common.
RELAY 2: NC	Isolated dry contact closure. Normally Closed.

Extra Large IP Display for InformaCast

Model No: WL-IPD-SPKR-540-INF

Specification Submittal

Installation

Please see cable routing installation video here - https://bit.ly/SMT-Cable_Installation

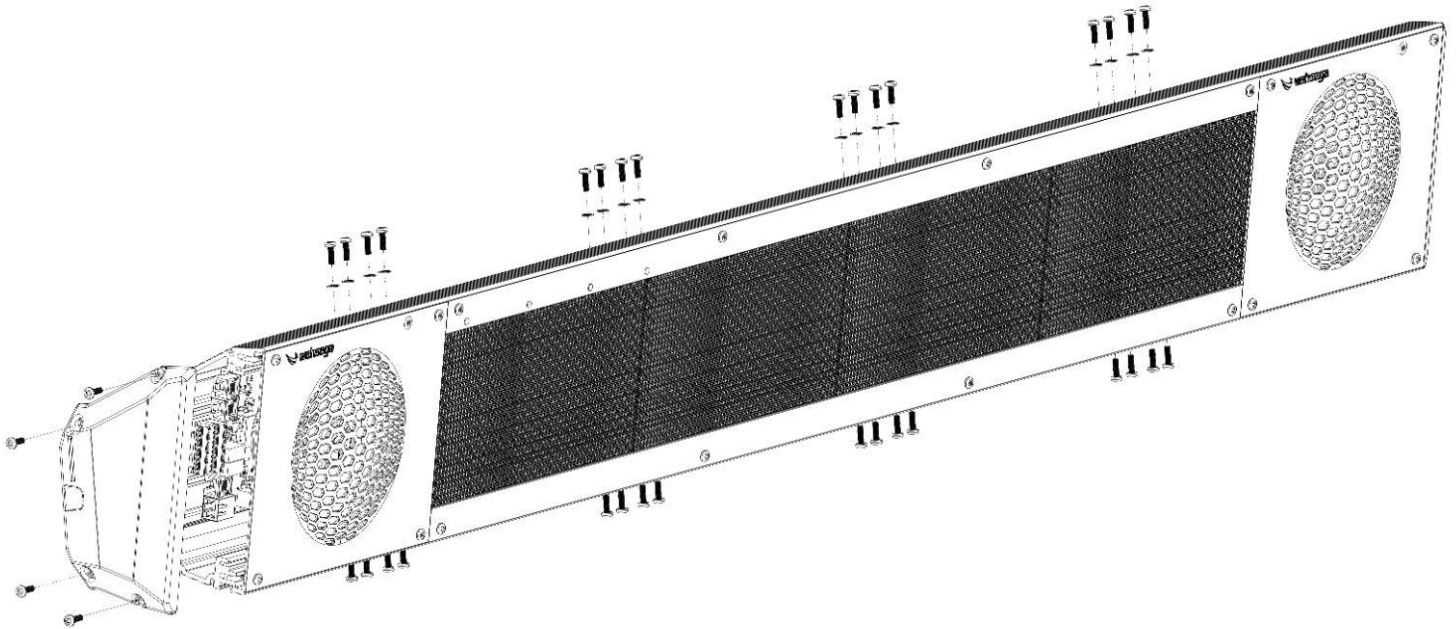

Attach 4 brackets to the IP Display 12.64 inches apart using included #8-32 screws and washers.

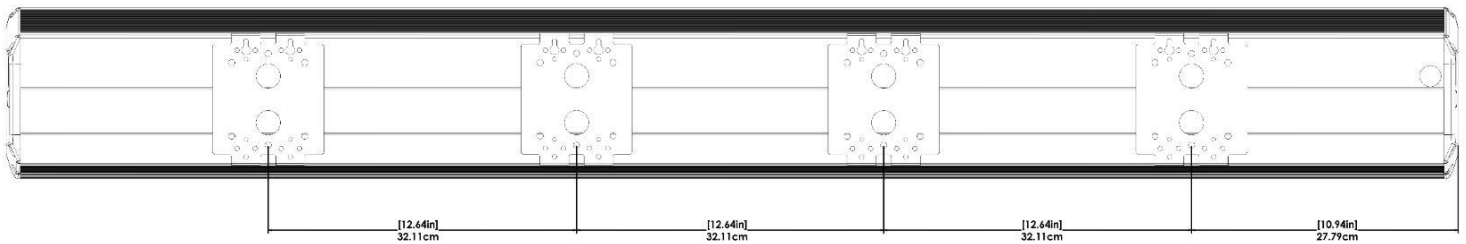

Job Name:	Date:	Location:
Notes:		

Extra Large IP Display for InformaCast

Model No: WL-IPD-SPKR-540-INF

Specification Submittal

Mounting and Installation

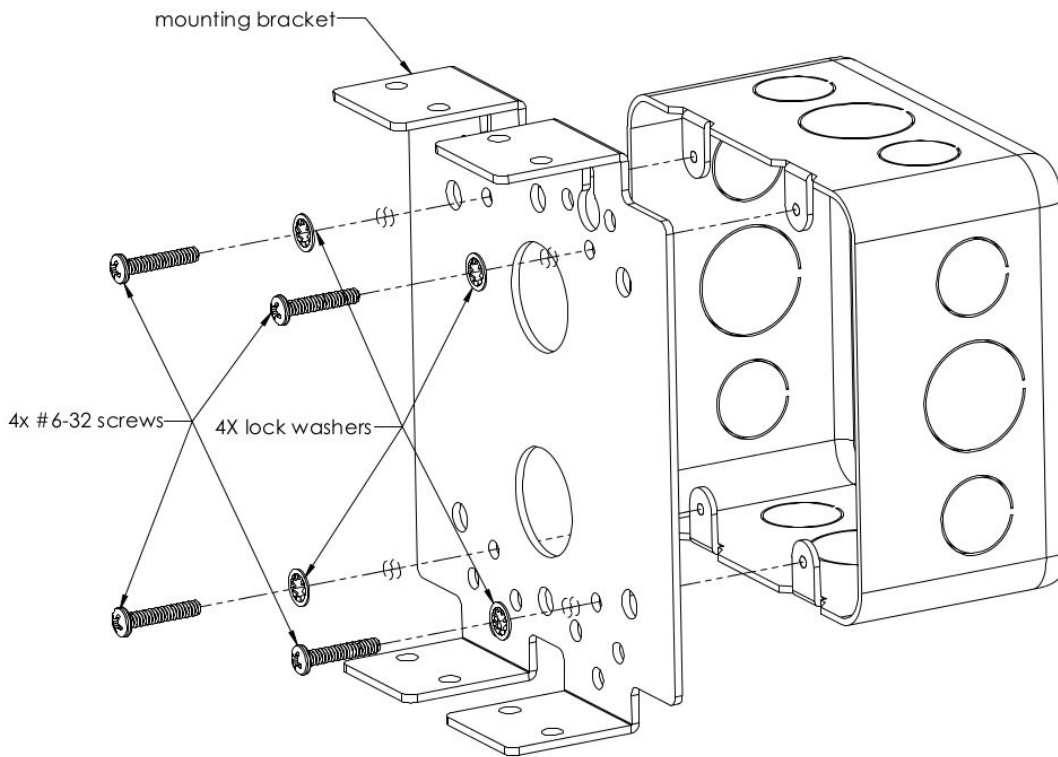

Mounting Bracket

Mount included bracket to the front of a standard two-gang electrical backbox (preferred), using (4) included #6-32 screws and lock washers. If mounting bracket to a solid surface rather than to an electrical backbox, use the appropriate bolts and anchors for that surface.

Job Name:	Date:	Location:
Notes:		